

AH1490T Air Cooler



AH series air cooler can be used in drain cooling system, return cooling system, lubrication cooling system and other independent cooling system. It is widely used in the system of many hydraulic power stations.

Characteristic

1. High density of fins are made by aluminum, increasing the cooling surface and very light of weight.
2. All electric motor has CE certification and very low noise when operation. Regular motor voltage is AC220 and AC380. If you need other voltage motor like AC110, DC12 or DC24, please contact with our salesman for further information.
3. Max. flow can be 250l/min, working pressure can be 35bar.

Dimensions (mm)

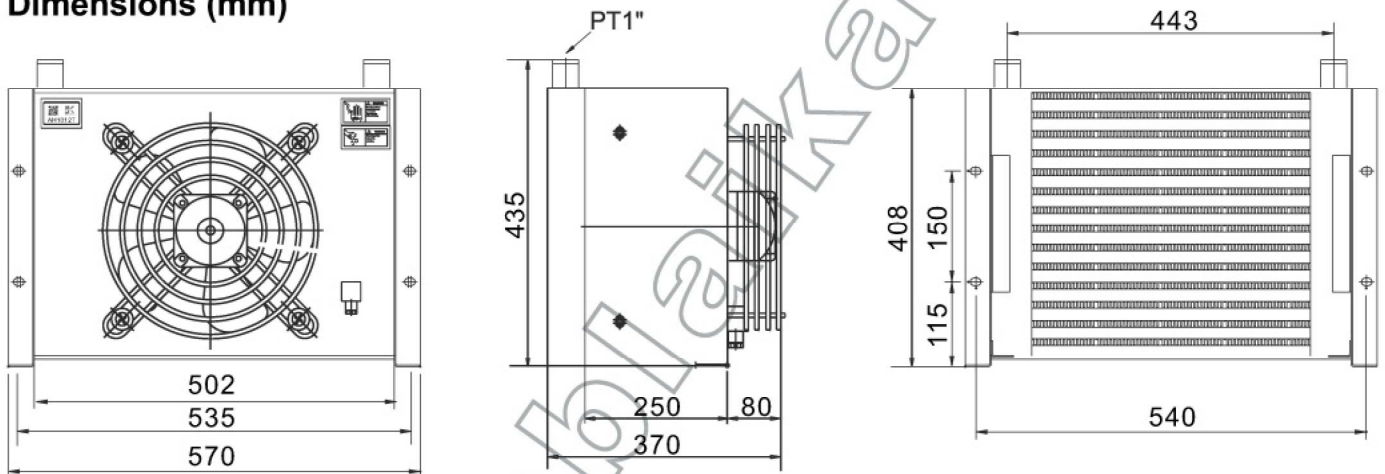

Performance Curve

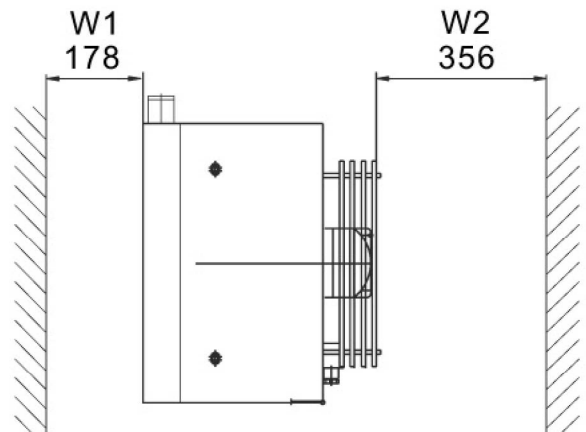
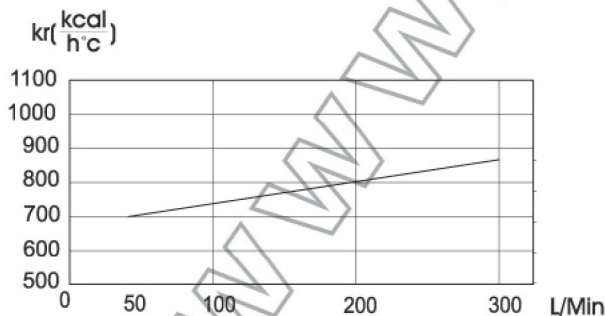

W1 is the min. distance between air inlet and obstacle
W2 is the min. distance between air outlet and obstacle