

Technical Features

- › 2-Way flow regulator, pressure compensated, with mounting interface acc. to ISO 4401, DIN 24340 (CETOP 03)
- › Set flow rate independent of load pressure and temperature changes
- › Adjusted flow rate depends on the orifice area and set differential pressure
- › Hardened precision parts
- › High flow capacity
- › Quiet and modulated response to load changes
- › Used in meter-in, meter out, or bleed-off applications
- › Wide range of flow rate options
- › Adjustable by allen key or hand screw
- › In the standard version, the valve is zinc coated for 240 h protection acc. to ISO 9227 and the valve body is phosphated

Functional Description

This pressure compensated, hydraulic flow regulator in the form of a sandwich plate with fixed orifice and variable spring setting is designed to control flow rates independently of pressure and temperature, especially in systems where only small movements due to load changes are required. The flow rate stabilization is provided by a pressure compensator in the direction from P2 to P1. The valve will maintain the set flow regardless of pressure variations on the regulated or inlet port. The regulated flow increases with clockwise rotation of the adjustment screw, the counter-clockwise rotation decreases the flow rate. Desired settings can be locked down.

ISO 4401-03-02-0-05

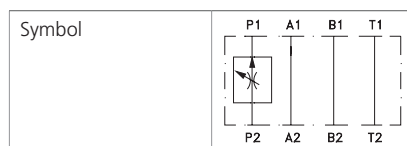
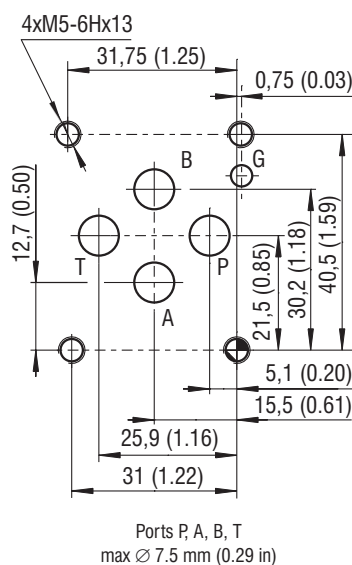

Technical Data

Valve size	06 (D03)								
Max. flow	l/min (GPM)		40 (11)						
Max. operating pressure	bar (PSI)		320 (4640)						
Nominal flow rates	l/min		1.6	2.5	4	6.3	10	16	20
	(GPM)		(0.4)	(0.7)	(1.1)	(1.7)	(2.6)	(4.2)	(5.3)
Fluid temperature range (NBR)	°C (°F)		-30 ... +100 (-22 ... +212)						
Fluid temperature range (FPM)	°C (°F)		-20 ... +120 (-4 ... +248)						
Mass - model MP06	kg (lbs)		1.12 (2.46)						

	Datasheet	Type
General information	GI_0060	Products and operating conditions
Mounting interface / tolerances	SMT_0019	ISO 4401-03-02-0-05 DIN 2430 (CETOP 03)
Spare parts	SP_8010	

Characteristics measured at $v = 32 \text{ mm}^2/\text{s}$ (156 SUS)

Regulated flow related to input pressure

Flow direction P2 - P1 (regulated flow)

Flow rate 1.6

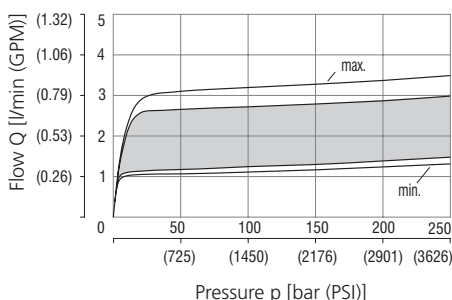

Flow rate 2.5

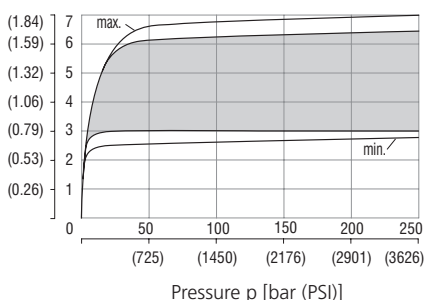

Flow rate 4

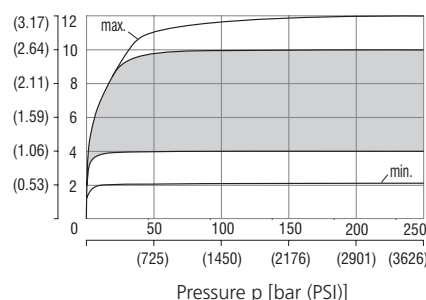

Characteristics measured at $v = 32 \text{ mm}^2/\text{s}$ (156 SUS)

Regulated flow related to input pressure

Flow direction P2 - P1 (regulated flow)

Flow rate 6.3

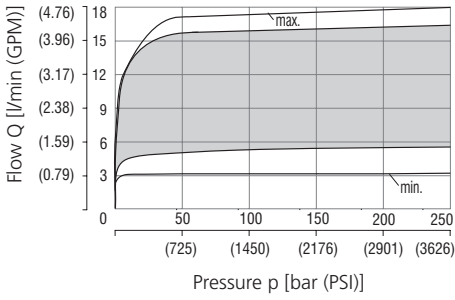

Flow rate 10

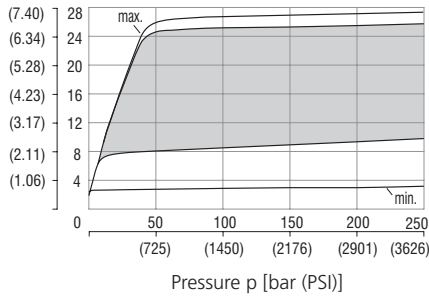

Flow rate 16

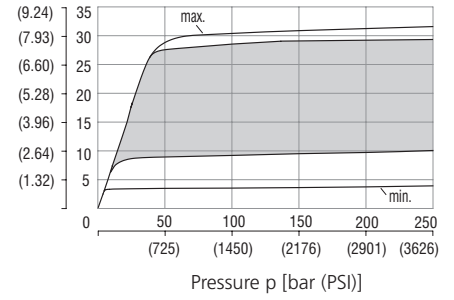

Flow rate 20

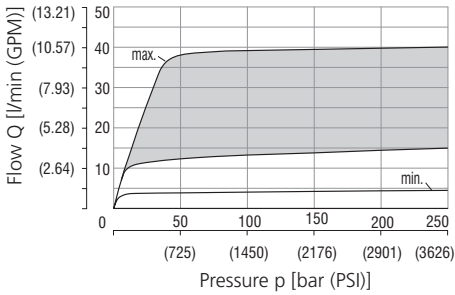

Pressure drop related to flow rate

Flow direction P1 - P2 (throttling without compensation)

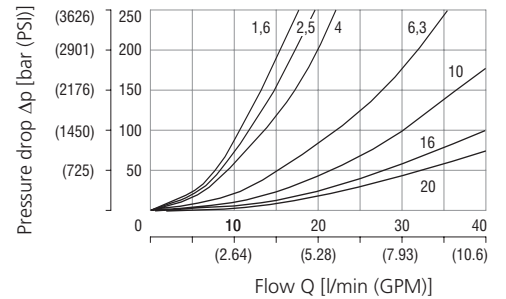

Dimensions in millimeters (inches)

Model S

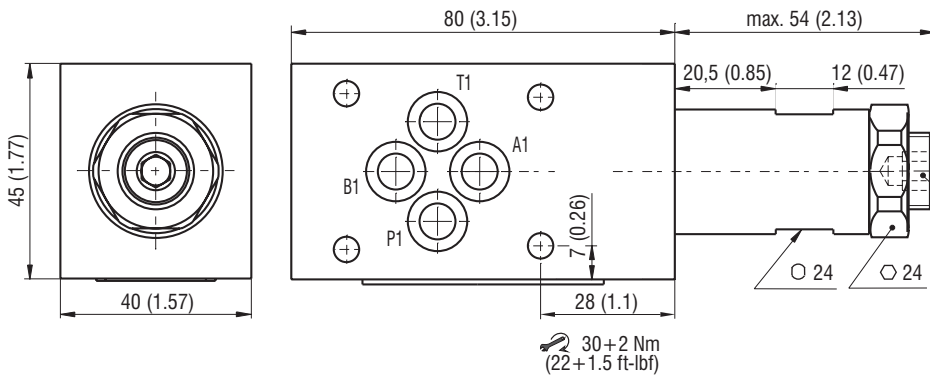

Model RS

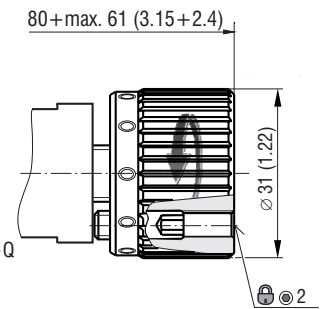

Ordering Code

VSS3-062 / MP06 - [] - [] - [] - []

2-Way flow regulator, pressure compensated

M22x1.5

Model

modular, valve function from P2 to P1

Flow rate

1.4 - 2.7 l/min	(0.4 - 0.7 GPM)	1.6
3 - 6 l/min	(0.8 - 1.6 GPM)	2.5
4 - 10 l/min	(1.1 - 2.6 GPM)	4
5 - 16 l/min	(1.3 - 4.2 GPM)	6.3
8 - 25 l/min	(2.1 - 6.6 GPM)	10
9 - 28 l/min	(2.4 - 7.4 GPM)	16
12 - 40 l/min	(3.2 - 10.6 GPM)	20

Surface treatment
 No des. body phosphated, steel parts
 zinc-coated (ZnCr-3), ISO 9227 (240 h)
 A zinc-coated (ZnCr-3), ISO 9227 (240 h)
 B zinc-coated (ZnNi), ISO 9227 (520 h)

Seals
 No designation V
 NBR
 FPM (Viton)

Adjustment option
 S allen key (hex. 6), without protective cap
 RS hand screw, metal-short